

2
SMALL SUMP COVERS WITH JONITE TRIMMER FRAME™

Sump covers for vehicular application (125KN - 400KN), must be flatly installed on a 90-degree edge to ensure maximum performance. Jonite Trimmer Frame™ provides this with a bonus of aesthetic flair.

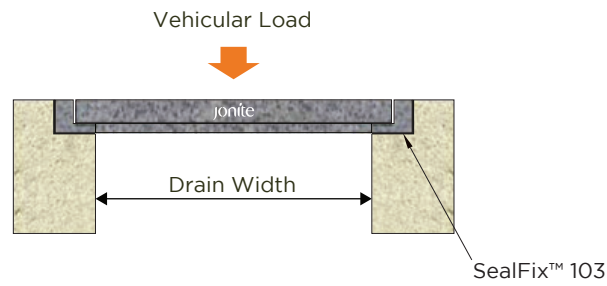

Jonite Trimmer Frame™ is installed using dry fixing with SealFix™ 103 (Epoxy mortar).

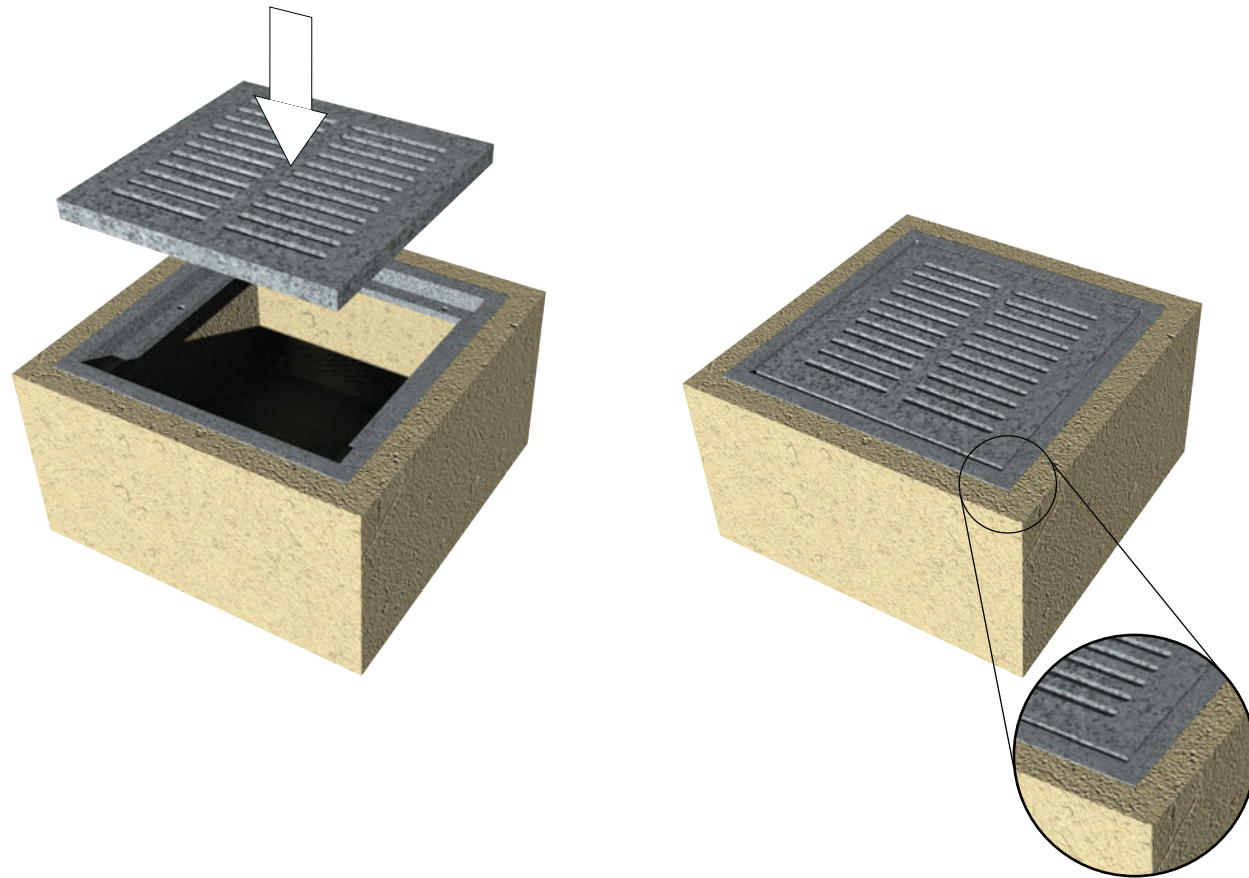

Jonite Trimmer Frame™ provides a clean and aesthetically appealing installation.

3
LARGE SUMP COVERS WITH L-STEEL ANGLES

For all large sump covers with multiple panels, a metal support frame is usually required. For sump covers requiring maintenance accessibility, a removable metal spline can be designed and fabricated.

For heavy-duty sump covers, they can be installed on a flat surface with a 90-degree edge by inverting an L-steel angle and welding a flat bar to the side. This is usually required on all four sides of the sump cover, creating a frame.

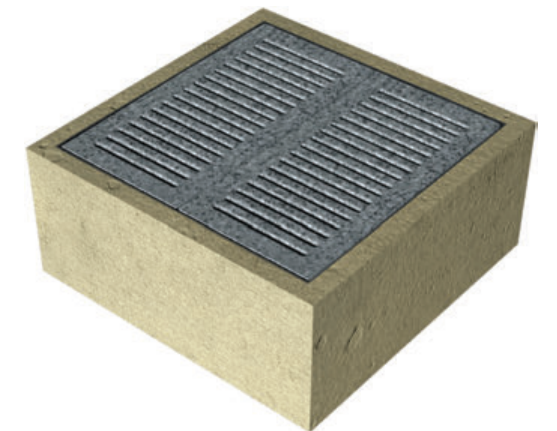
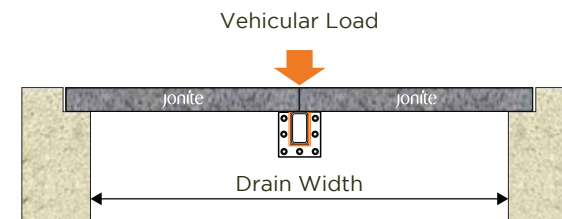
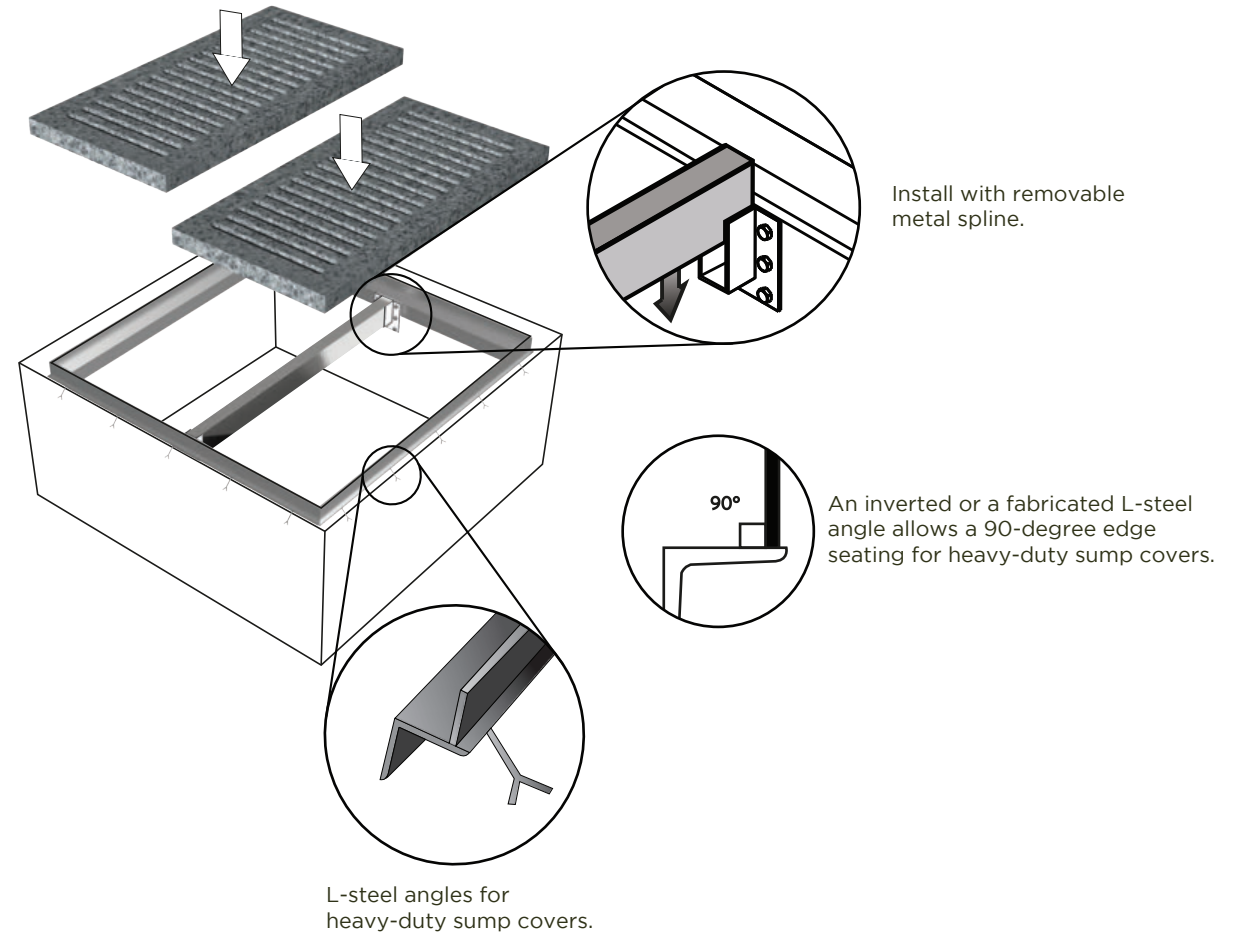

4
LARGE SUMP COVERS WITH JONITE TRIMMER FRAME™

Large sump covers with multiple panels can also use a Jonite Trimmer Frame™ as an alternative to the L-steel metal frame support. The Trimmer Frame™ provides the same 90-degree edge flat surface as the L-steel metal frame with an aesthetic bonus.

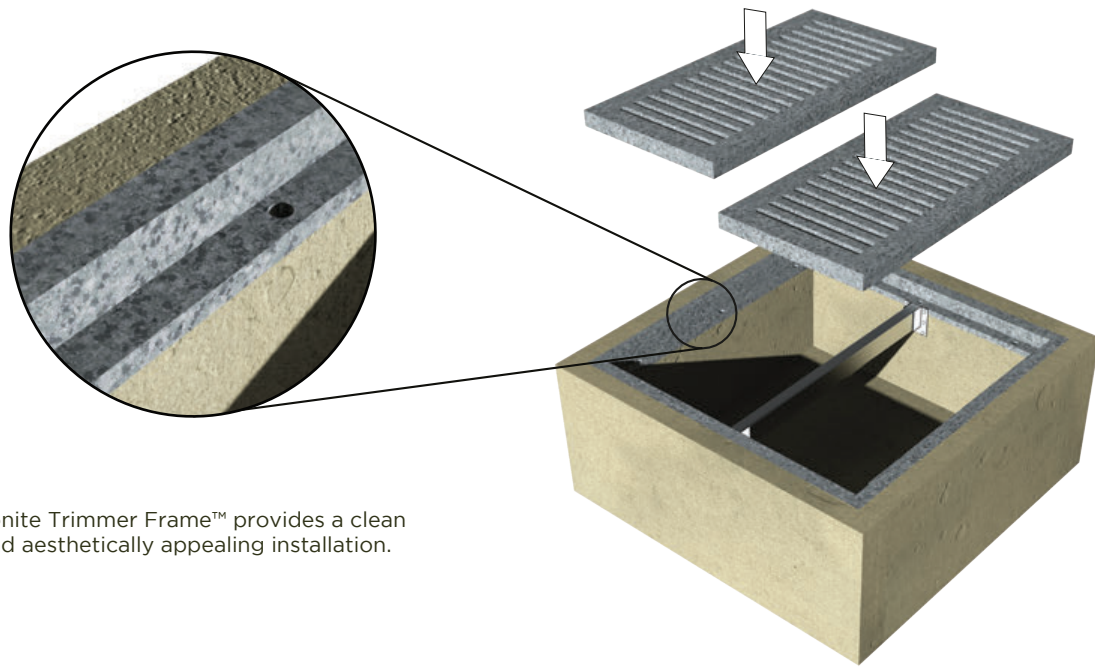

Jonite Trimmer Frame™ provides a clean and aesthetically appealing installation.

5
BASIN GRATES

Jonite basin grates are similar to sump covers functionally as a grate for a point drainage system. The main difference, however, is that the basin grates are specially designed to fit a specific model of a manufactured catch basin.

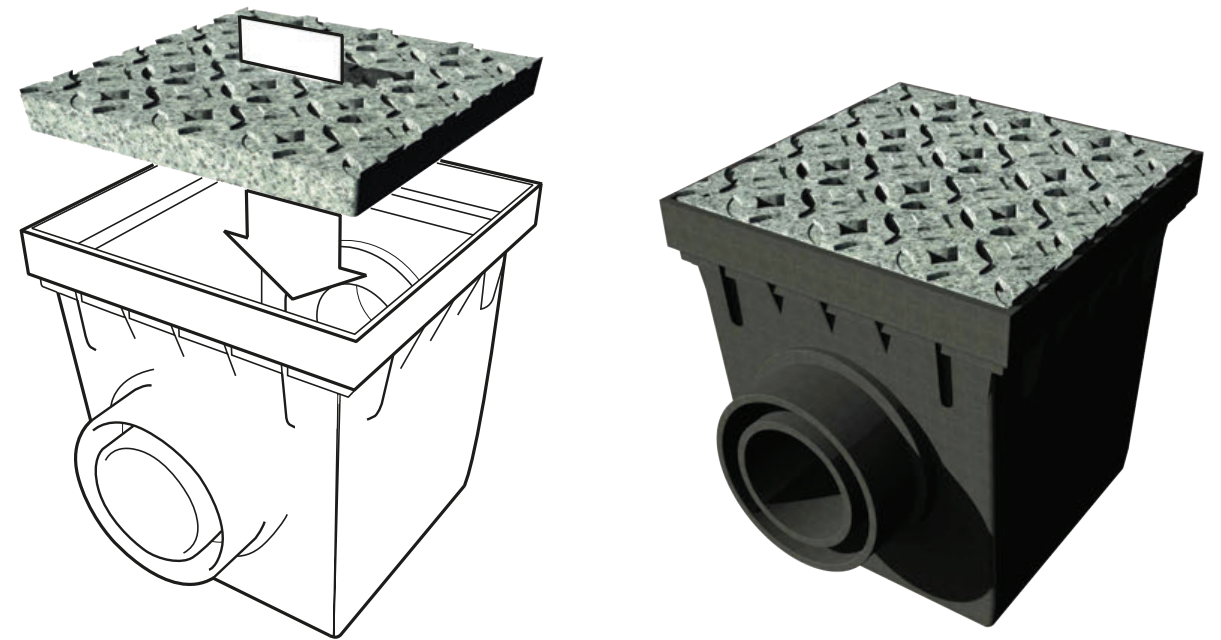

Install directly on the compatible catch basins

Basin grates are perfectly shaped to fit most catch basins.

