

## 952 100mm x 50mm - Load Class A10

FOR CONCRETE

### Specification Clause

The surface drainage system shall be Sabdrain 952 100 50 polypropylene plastic channel, fitted with marine grade stainless steel heel guard anti-slip grating Load Class - A10

### Properties

Sabdrain 952 10050 polypropylene plastic channels shall meet the following properties:-

COMPRESSIVE STRENGTH	<b>58N/mm<sup>2</sup></b>
TENSILE STRENGTH	<b>14N/mm<sup>2</sup></b>
DENSITY	<b>0.960 g/cm<sup>3</sup></b>
WATER ABSORPTION	<b>&lt;0.05%</b>
THERMAL EXPANSION COEFFICIENT	<b>15x10<sup>-5</sup> mm/°C</b>
FROST PROOF	<b>YES</b>
MELTING POINT	<b>162 - 168 °C</b>
COEFFICIENT OF ROUGHNESS	<b>N=0.010</b>
CHEMICAL RESISTENCE	<b>YES</b>
NON FLAMMABLE	<b>YES</b>

for detailed chemical resistance, refer to <https://sabdrain.com.au/chemical-resistance/>

### Dimensions

Sabdrain 952 10050 channels dimensions shall be an internal height of 50mm with an internal width of 100mm and an overall height of 80mm and width of 150mm, with Male/Female interlocking joints, the channels shall have provision to create a 2° (17M) Radius.

### Grates

Refer to the relevant specification sheet for the selected grate.

### Installation

The Sabdrain 952 100150 Drainage system shall be installed for its intended purpose. Any improper installation and usage could result in product failure.

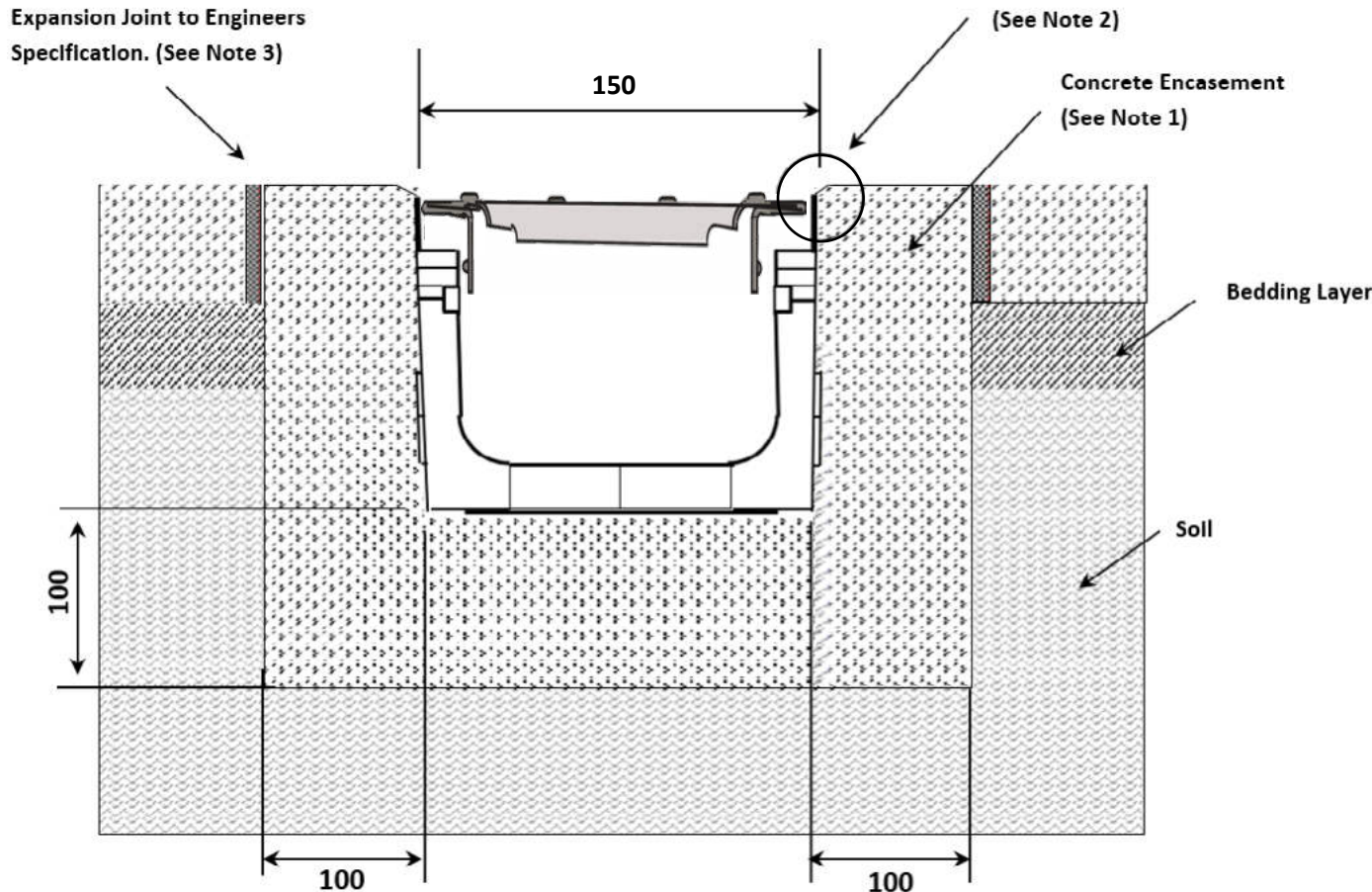

### Notes

1. Concrete encasement dimensions and/or reinforcement changes may be required for specific site conditions. Minimum concrete strength of 25MPa is recommended. Ensure concrete is vibrated Alwaysseek engineering advice.
2. The finished level of the concrete encasement should be 3-5mm above the channel edge.
3. Expansion control joints are recommended for protection of the concrete encasement.

