

SABdrain

water drainage systems

902 200mm x 200mm - Load Class A10

FOR CONCRETE

Specification Clause

The surface drainage system shall be Sabdrain 902 200 200 polypropylene plastic channel, fitted with 304 stainless steel heel guard anti-slipgrating Load Class - A10

Properties

Sabdrain 902 200200 polypropylene plastic channels shall meet the following properties:-

COMPRESSIVE STRENGTH	58N/mm²
TENSILE STRENGTH	14N/mm²
DENSITY	0.960 g/cm³
WATER ABSORPTION	<0.05%
THERMAL EXPANSION COEFFICIENT	15x12⁻⁵ mm/°C
FROST PROOF	YES
MELTING POINT	162 – 168 °C
CO EFFICIENT OF ROUGHNESS	N=0.010
CHEMICAL RESISTENCE	YES
NON FLAMMABLE	YES

for detailed chemical resistance, refer to <https://sabdrain.com.au/chemical-resistance/>

Dimensions

Sabdrain 902 200200 channels dimensions shall be an internal height of 200mm with an internal width of 200mm and an overall height of 250mm and width of 250mm, with Male/Female interlocking joints, the channels shall have provision to create a 2° (17M) Radius.

Grates

Refer to the relevant specification sheet for the selected grate.

Installation

The Sabdrain 902 200200 Drainage system shall be installed for its intended purpose. Any improper installation and usage could result in product failure.

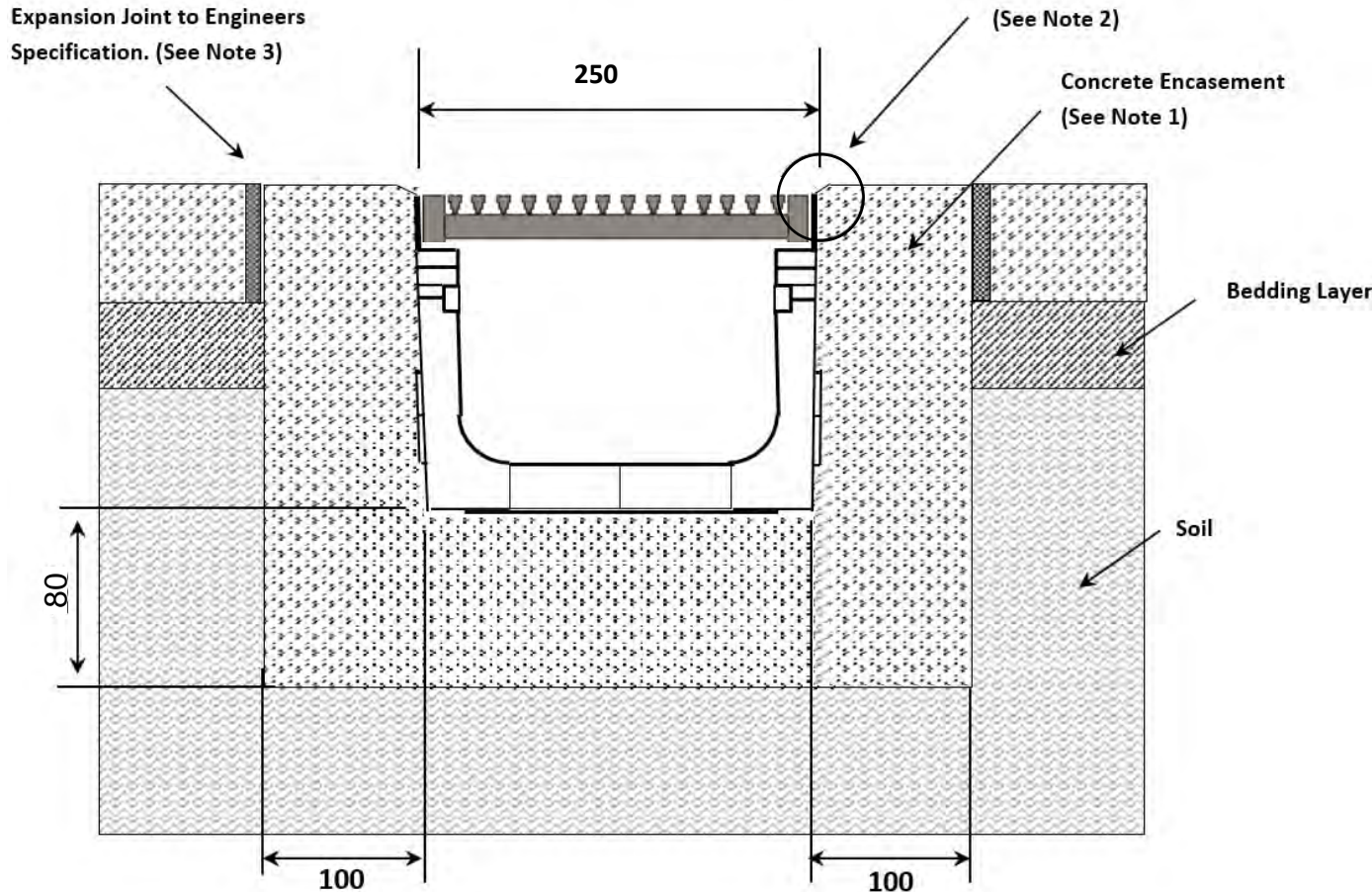

Notes

1. Concrete encasement dimensions and/or reinforcement changes may be required for specific site conditions. Minimum concrete strength of 25MPa is recommended. Ensure concrete is vibrated Alwaysseek engineering advice.
2. The finished level of the concrete encasement should be 3-5mm above the channel edge.
3. Expansion control joints are recommended for protection of the concrete encasement.

