

# SABdrain

water drainage systems

## 901 200mm x 100mm - Load Class A10

FOR CONCRETE

### Specification Clause

The surface drainage system shall be Sabdrain 901 200 100 polypropylene plastic channel, fitted with 304 stainless steel heel guard grating Load Class - A10

### Properties

Sabdrain 901 200100 polypropylene plastic channels shall meet the following properties:-

COMPRESSIVE STRENGTH	<b>58N/mm<sup>2</sup></b>
TENSILE STRENGTH	<b>14N/mm<sup>2</sup></b>
DENSITY	<b>0.960 g/cm<sup>3</sup></b>
WATER ABSORPTION	<b>&lt;0.05%</b>
THERMAL EXPANSION COEFFICIENT	<b>15x10<sup>-5</sup> mm/°C</b>
FROST PROOF	<b>YES</b>
MELTING POINT	<b>162 – 168 °C</b>
CO EFFICIENT OF ROUGHNESS	<b>N=0.010</b>
CHEMICAL RESISTENCE	<b>YES</b>
NON FLAMMABLE	<b>YES</b>

for detailed chemical resistance, refer to <https://sabdrain.com.au/chemical-resistance/>

### Dimensions

Sabdrain 901 200100 channels dimensions shall be an internal height of 100mm with an internal width of 200mm and an overall height of 150mm and width of 250mm, with Male/Female interlocking joints, the channels shall have provision to create a 2° (17M) Radius.

### Grates

Refer to the relevant specification sheet for the selected grate.

### Installation

The Sabdrain 901 200100 Drainage system shall be installed for its intended purpose. Any improper installation and usage could result in product failure.

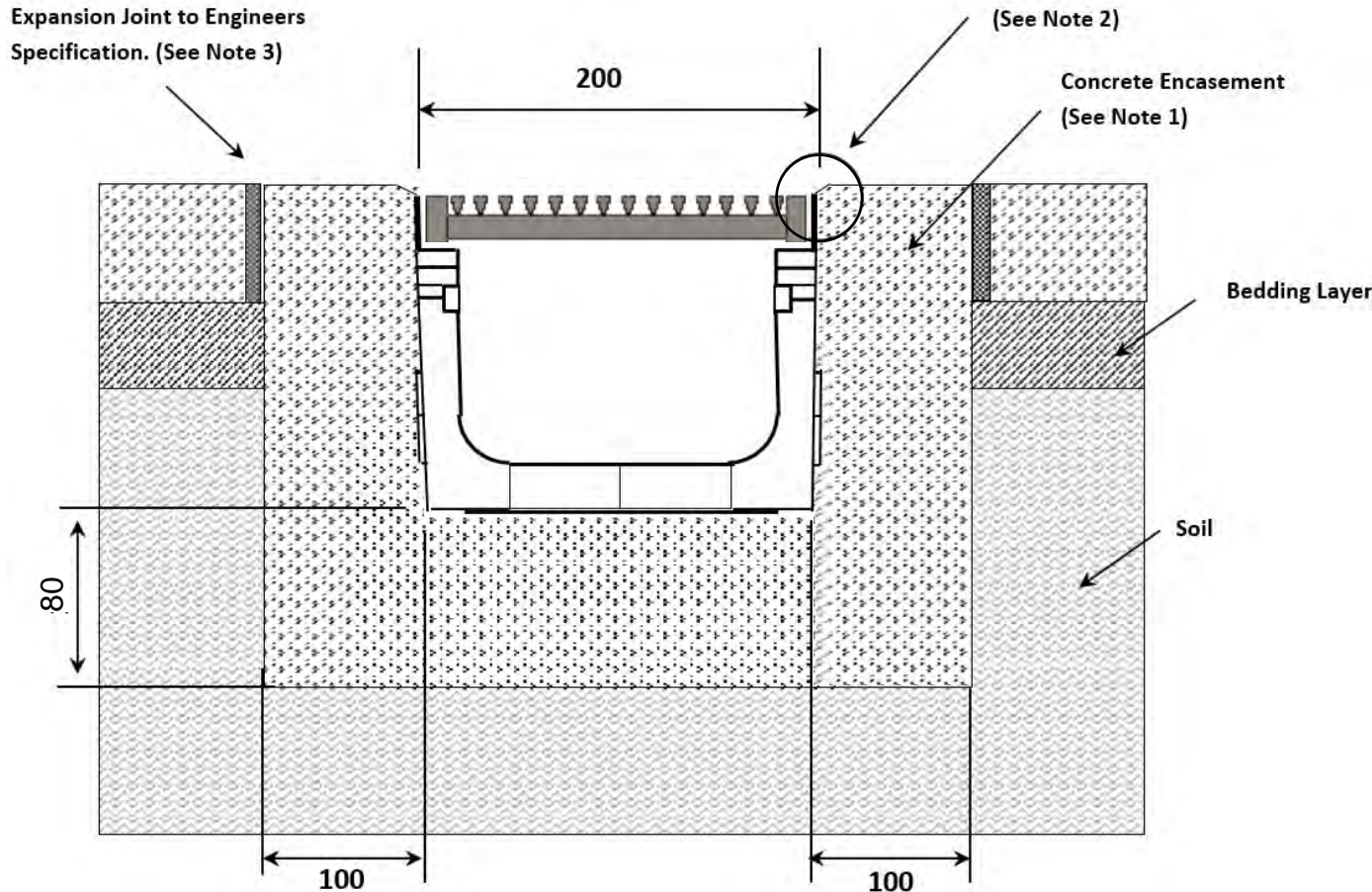

### Notes

1. Concrete encasement dimensions and/or reinforcement changes may be required for specific site conditions. Minimum concrete strength of 25MPa is recommended. Ensure concrete is vibrated Alwaysseek engineering advice.
2. The finished level of the concrete encasement should be 3-5mm above the channel edge.
3. Expansion control joints are recommended for protection of the concrete encasement.

