

# SABdrain

water drainage systems

## 705 200mm x 50mm Load Class E400

FOR CONCRETE

### Specification Clause

The surface drainage system Sabdrain 705 20050 polypropylene plastic channel fitted with Cast Iron Grating, Load Class Rating – E400.\*

\*Load Classification AS3996:2006 E400 is similar to EN1433:2008 D400.

### Properties

Sabdrain 705 20050 polypropylene plastic channels shall meet the following properties:-

COMPRESSIVE STRENGTH	<b>58N/mm<sup>2</sup></b>
TENSILE STRENGTH	<b>14N/mm<sup>2</sup></b>
DENSITY	<b>0.960 g/cm<sup>2</sup></b>
WATER ABSORPTION	<b>&lt;0.05%</b>
THERMAL EXPANSION COEFFICIENT	<b>15x10<sup>-5</sup> mm/°C</b>
FROST PROOF	<b>YES</b>
MELTING POINT	<b>162 - 168 °C</b>
COEFFICIENT OF ROUGHNESS	<b>N=0.010</b>
CHEMICAL RESISTANCE	<b>YES</b>
NON FLAMMABLE	<b>YES</b>

for detailed chemical resistance, refer to <https://sabdrain.com.au/chemical-resistance/>

### Dimensions

Sabdrain 705 20050 channels dimensions shall be an internal height of 50mm with an internal width of 200mm and an overall height of 100mm and width of 250mm, with Male/Female interlocking joints, the channels shall have provision to create a 2° (17M) Radius.

### Grates

Refer to the relevant specification sheet for the selected grate.

### Installation

The Sabdrain 705 20050 Drainage system shall be installed for its intended purpose. Any improper installation and usage could result in product failure.

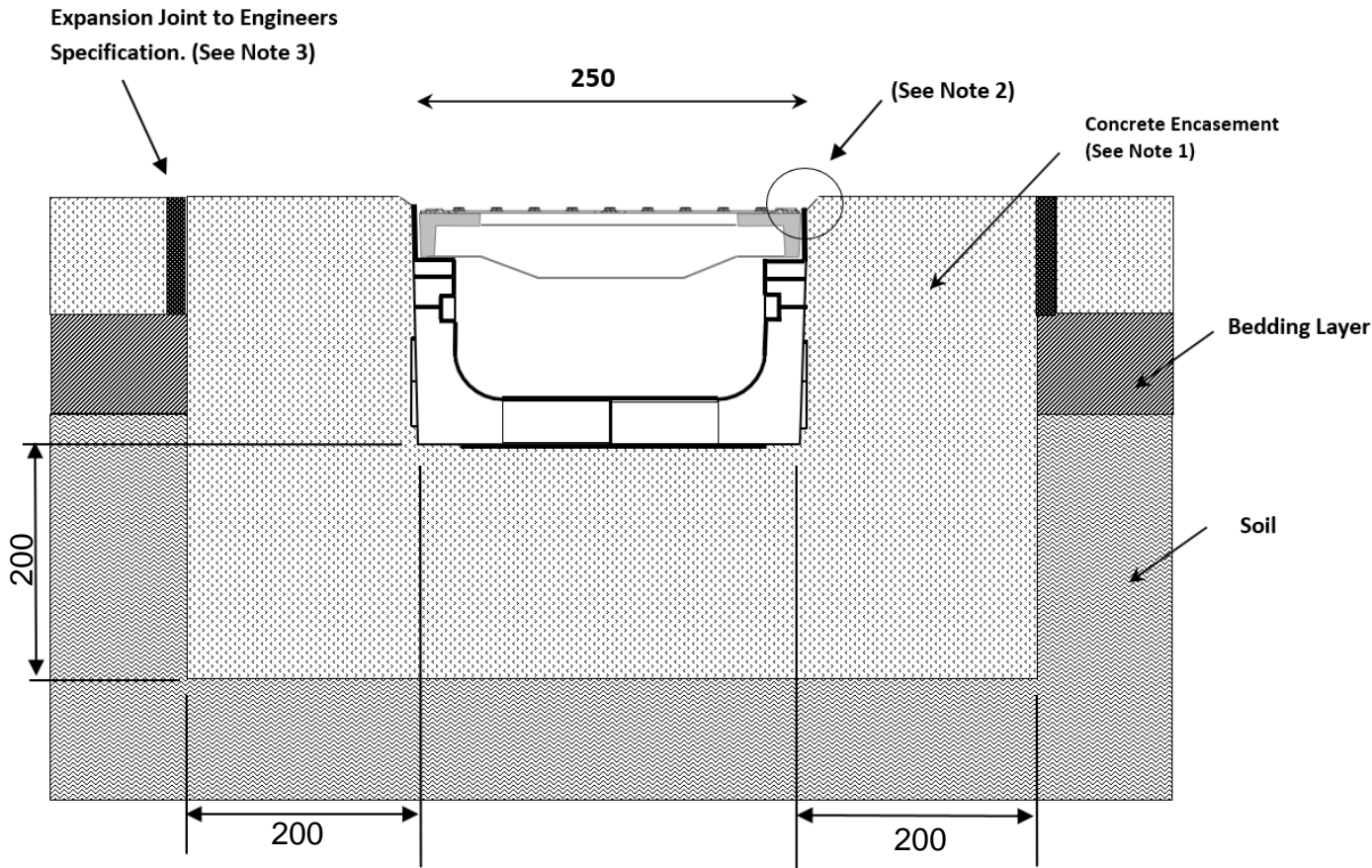

### Notes

1. Concrete encasement dimensions and/or reinforcement changes may be required for specific site conditions. Minimum concrete strength of 25MPa is recommended. Ensure concrete is vibrated Always seek engineering advice.
2. The finished level of the concrete encasement should be 3-5mm above the channel edge.
3. Expansion control joints are recommended for protection of the concrete encasement.

