

# Jonite

Breeze Blocks:  
**The Comprehensive  
Installation Manual**

## Table of Contents



<b>01</b>	<b>OCCUPATIONAL SAFETY &amp; HYGIENE PROTOCOLS</b>	<b>1</b>
<b>02</b>	<b>ESSENTIAL TOOLS AND PROPRIETARY MATERIALS</b>	<b>1</b>
<b>03</b>	<b>TECHNICAL SPECIFICATIONS</b>	<b>2</b>
<b>04</b>	<b>PRECISE JOINT SPACING STANDARDS</b>	<b>2</b>
<b>05</b>	<b>ARCHITECTURAL CONSIDERATIONS</b>	<b>2</b>
	WALL DIMENSIONS AND CONTROL JOINTS	
<b>06</b>	<b>PRELIMINARY SITE EVALUATION</b>	<b>3</b>
<b>07</b>	<b>MASTERCLASS INSTALLATION PROTOCOL</b>	<b>3</b>
	REINFORCEMENT WITH REBAR	
<b>08</b>	<b>WIND LOAD AND ENVIRONMENTAL CONSIDERATIONS</b>	<b>3</b>
<b>09</b>	<b>THE JONITE PALETTE: MORTAR COLOUR SELECTION</b>	<b>4</b>
<b>10</b>	<b>ALTERNATIVE APPLICATIONS</b>	<b>4</b>
<b>11</b>	<b>FINALISATION AND REFINEMENT</b>	<b>5</b>
<b>12</b>	<b>QUALITY ASSURANCE AND INSPECTION</b>	<b>5</b>

## 01

### OCCUPATIONAL SAFETY & HYGIENE PROTOCOLS

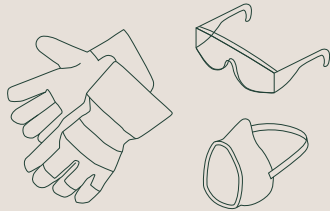

#### Health and safety are paramount.

Adhere to certified Personal Protective Equipment (**PPE**) guidelines, including the use of gloves, safety goggles, and dust masks.

## 02

### ESSENTIAL TOOLS AND PROPRIETARY MATERIALS

#### Essential Tools

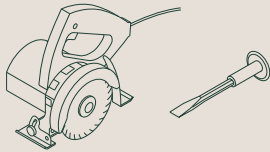

- Precision Masonry Saw or Chisel

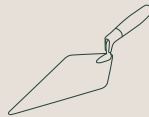

- Professional-grade Trowel

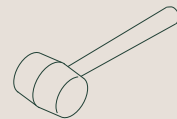

- Industrial Rubber Mallet

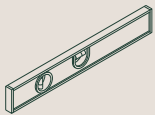

- High-accuracy Level

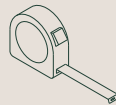

- Premium Measuring Tape

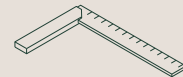

- Carpenter's Square

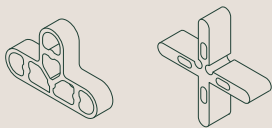

- Optional Spacers



- Distilled Water

#### Proprietary Materials

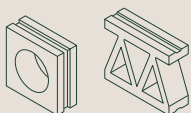

- Jonite Breeze Blocks



- Jonite's Pre-mixed Epoxy Mortars

**03**  
**TECHNICAL SPECIFICATIONS**

Material Characteristics

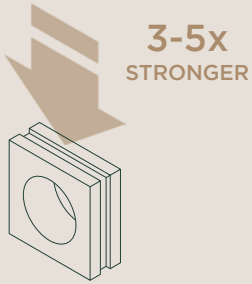

- **Strength:** Jonite stone composite offers a tensile and compressive strength 3-5 times higher than traditional concrete.
- **Customisation:** Custom dimensions are available upon request to meet specific architectural needs.

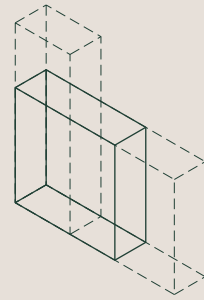

**04**  
**PRECISE JOINT SPACING STANDARDS**

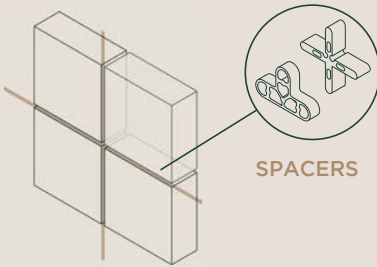

- Opt for a uniform joint **spacing of between 6-10mm** between blocks. This ensures structural stability and aesthetic consistency. Utilise spacers to ensure consistent joint distances.

**05**  
**ARCHITECTURAL CONSIDERATIONS: WALL DIMENSIONS AND CONTROL JOINTS**

Free-Standing Wall

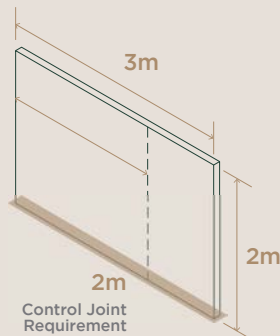

Retaining Wall

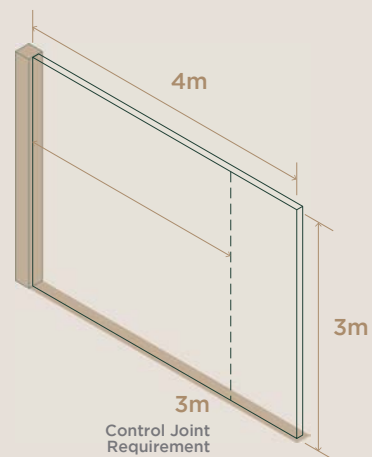

Dimensional Criteria Table

Type of Wall	Height Cap	Width Cap	Control Joint Requirement
Free-Standing Wall	2m	3m	2m Intervals
Retaining Wall	3m	4m	3m Intervals

\* Consult an architectural engineer for projects exceeding these dimensions.

## 06

### PRELIMINARY SITE EVALUATION

- Ensure the designated installation surface is clean, dry, and level. Take accurate measurements for block placement and control joints.

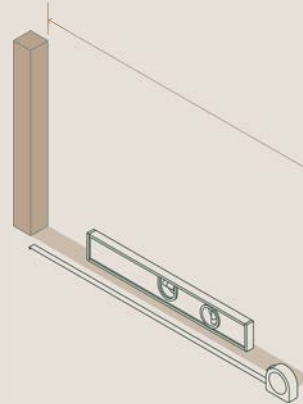

## 07

### MASTERCLASS INSTALLATION PROTOCOL

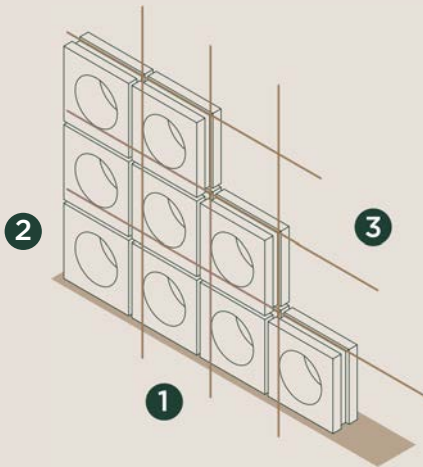

### REINFORCEMENT WITH REBAR

#### Rebar Implementation Protocol

1. Anchor vertical rebars into the foundation and slot them into the vertical block grooves.
2. Install the first course of Breeze Blocks, incorporating horizontal rebar into the horizontal block grooves.
3. Continue with subsequent layers, threading additional horizontal rebars as needed.

#### Rebar Implementation Guidelines

- **Up to 2m in Height:** Use vertical rebars for free-standing walls.



- **Beyond 2m in Height:** Both vertical and horizontal rebars are required.

## 08

### WIND LOAD AND ENVIRONMENTAL CONSIDERATIONS

- For external installations, especially in high-wind areas, additional reinforcement may be advisable. Comply with local building codes and perform a wind load analysis.

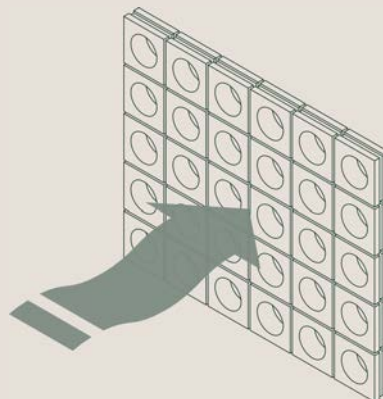

09

THE JONITE PALETTE:  
MORTAR COLOUR SELECTION



- Opt for Jonite's range of pre-mixed epoxy mortars available in matching colours for a seamless aesthetic experience.

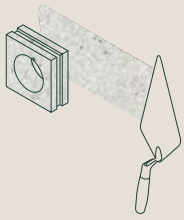

IVORY WHITE

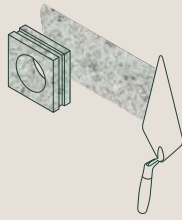

WACKY WHITE

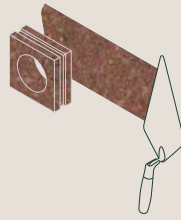

TERRACOTA RED

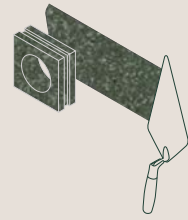

BAMBOO GREEN

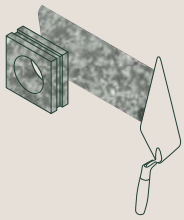

STEEL GREY

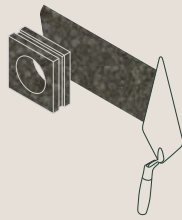

MOCCA BROWN

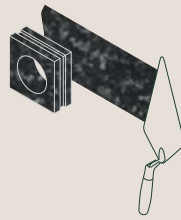

EBONY BLACK



+16 COLOUR OPTIONS

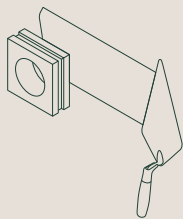

- **Customisation:** Custom Mortar colours are available upon request to meet specific architectural needs.

10

ALTERNATIVE  
APPLICATIONS

- Jonite Breeze Blocks offer versatility beyond façades and internal walls. They can also serve as aesthetic partitions, property fences, and even garden features.



## 11

### FINALISATION AND REFINEMENT



- Remove excess mortar with a damp sponge.



- Ensure all observable gaps are filled with mortar.

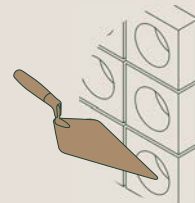

- **Aesthetic Option:** Consider filling the groove gaps of the blocks for a unique aesthetic texture.

## 12

### QUALITY ASSURANCE AND INSPECTION



Upon completion, perform a comprehensive quality check to ensure:

- All rebars are securely anchored.
- Mortar has been evenly applied and set.
- Wall is perfectly level and aligned.

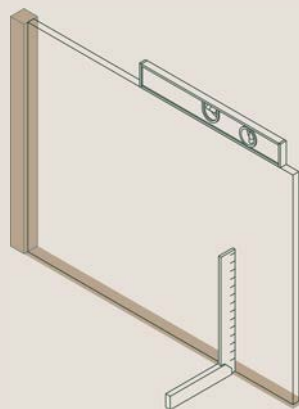
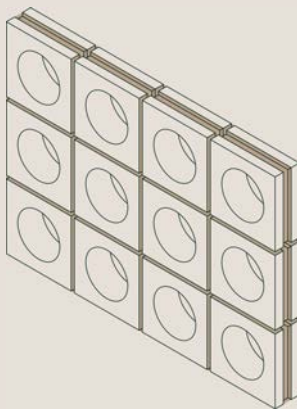

---

Your architectural vision is now fortified with Jonite's ingenuity and craft. This comprehensive guide aims to equip you with the expertise to bring that vision to life.

Thank you for choosing Jonite, the epitome of architectural excellence.

Disclaimer:

This manual is an architectural adjunct.  
Always comply with local architectural  
and structural codes.

Website

[www.jonite.com](http://www.jonite.com)

Social Media

 [facebook.com/jonitestone](https://facebook.com/jonitestone)

 [pinterest.com/jonitestone](https://pinterest.com/jonitestone)

 [linkedin.com/company/jonitestone](https://linkedin.com/company/jonitestone)

 [instagram.com/jonitestone](https://instagram.com/jonitestone)

Email

[info@jonite.com](mailto:info@jonite.com)