

952 100mm x 50mm - Load Class A10

FOR ASPHALT

Specification Clause

The surface drainage system shall be Sabdrain 952 100 50 polypropylene plastic channel, fitted with marine grade stainless steel heel guard anti-slip grating Load Class - A10

Properties

Sabdrain 952 100150 polypropylene plastic channels shall meet the following properties:-

COMPRESSIVE STRENGTH	58N/mm²
TENSILE STRENGTH	14N/mm²
DENSITY	0.960 g/cm³
WATER ABSORPTION	<0.05%
THERMAL EXPANSION COEFFICIENT	15x10⁻⁵ mm/°C
FROST PROOF	YES
MELTING POINT	162 - 168 °C
COEFFICIENT OF ROUGHNESS	N=0.010
CHEMICAL RESISTENCE	YES
NON FLAMMABLE	YES

for detailed chemical resistance, refer to <https://sabdrain.com.au/chemical-resistance/>

Dimensions

Sabdrain 952 10050 channels dimensions shall be an internal height of 50mm with an internal width of 100mm and an overall height of 80mm and width of 150mm, with Male/Female interlocking joints, the channels shall have provision to create a 2° (17M) Radius.

Grates

Refer to the relevant specification sheet for the selected grate.

Installation

The Sabdrain 952 10050 Drainage system shall be installed for its intended purpose. Any improper installation and usage could result in product failure.

Expansion Joint to Engineers Specification. (See Note 3)

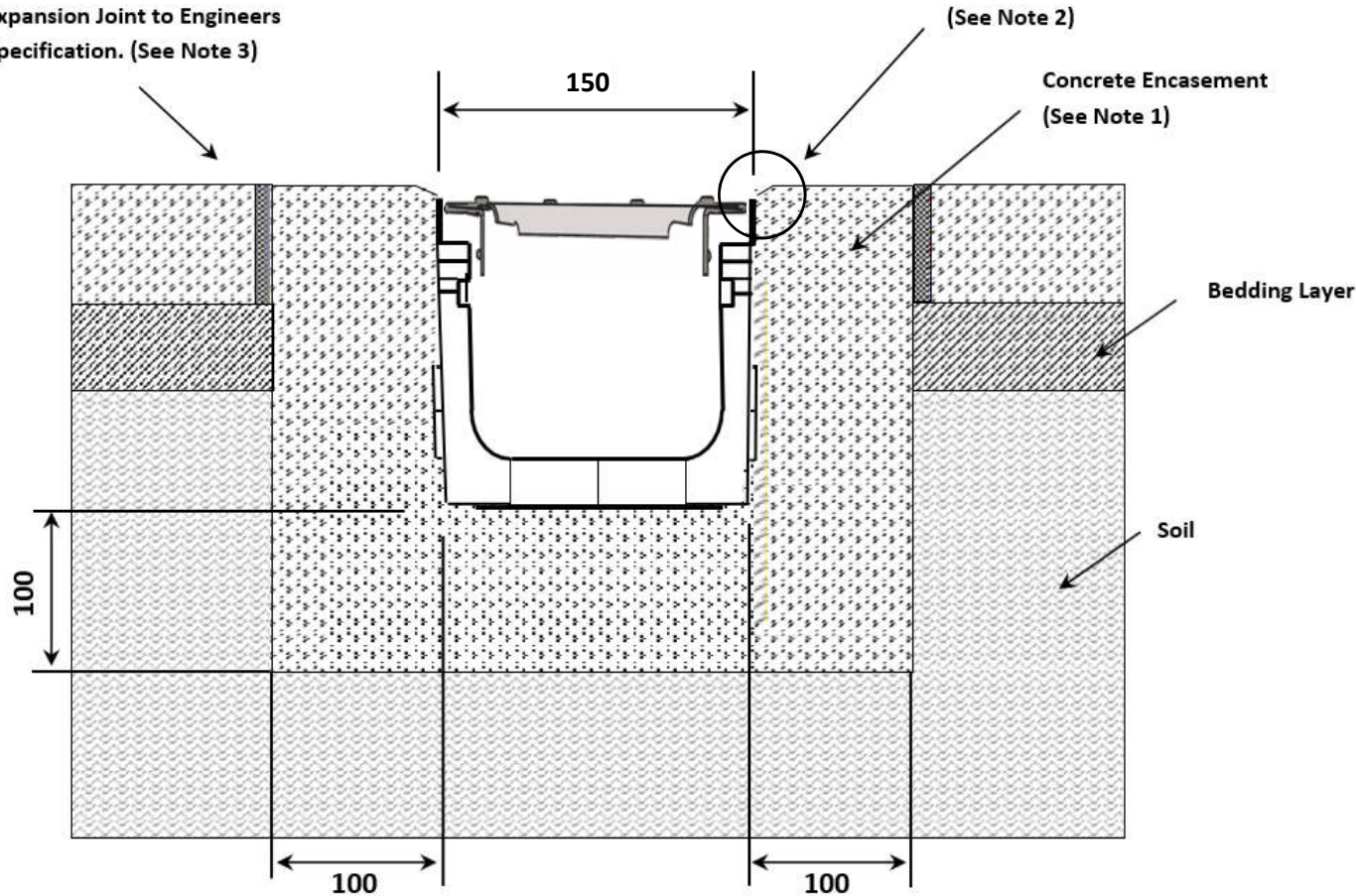

Notes

1. Concrete encasement dimensions and/or reinforcement changes may be required for specific site conditions. Minimum concrete strength of 25MPa is recommended. Ensure concrete is vibrated Alwaysseek engineering advice.
2. The finished level of the concrete encasement should be 3-5mm above the channel edge.
3. Expansion control joints are recommended for protection of the concrete encasement.

