

Overall Size 195W x 500L x 22mm(t)
Application **Strictly For Pedestrian Only**
Load Class A15 (up to 15KN)
(Compliant with EN124.1994)

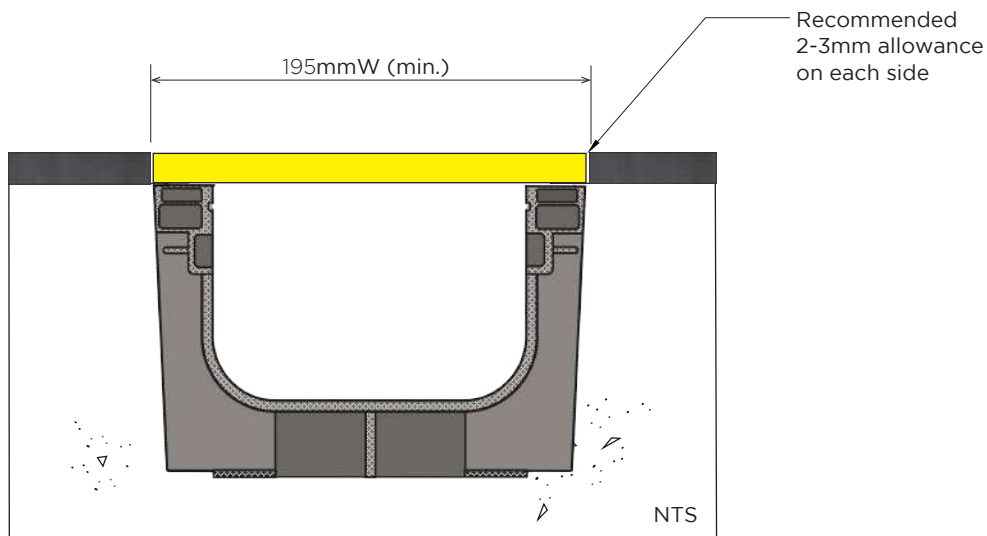

© Jonite®. All rights reserved.

